

### Overview

- 4MP (2688\*1520)
- True WDR 120dB
- 4.8mm to 120mm Lens / 25x Optical Zoom
- H.265
- IR distance up to 100m / 328ft
- IP67, IK10 Rated







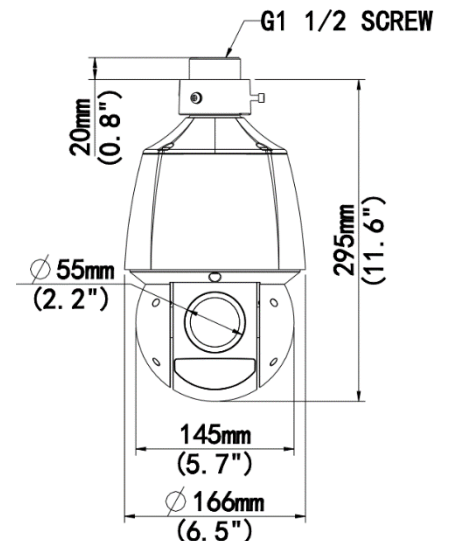

















### Technical Specifications

Device	
Image Sensor:	1 / 2.8", 4MP Progressive Scan CMOS
Min Illumination:	Color: 0.003Lux (F1.5, AGC ON)   0Lux with IR
Shutter Time:	Auto/Manual, 1 ~ 1/100000s
Lens:	4.8mm to 120mm AF automatic focusing and motorized zoom lens
True WDR:	120 dB
Angle of View :	H: 52.20°~2.74°, V: 30.81°~1.54°, O: 64.20°~3.23°
Angle Adjustment:	360° (endless), -15° ~ 90° (auto reverse)
Digital Zoom	16x
Optical Zoom	25x
Day & Night:	IR-Cut Filter with Auto Switch (ICR)
IR Range:	Up to 100m (328ft) IR range
Compression Standard	
Video Compression:	H.265, H.264, MJPEG
Video Bit Rate:	128 Kbps~16 Mbps
Tri-Stream:	Yes
Analytics:	Motion Detection, Motion detection, Audio detection, Tampering Alarm, Line crossing detection, Intrusion Detection, Enter Area, Leave Area Detection
Image	
Max. Image Resolution:	2688*1520
Frame Rate:	30fps (2688*1520)
ROI Codec:	Support
Image Setting:	White Balance, Digital Noise Reduction, Smart IR, HLC, BLC, Defog



## Technical Specifications

<b>Network</b>										
Protocols:	IPv4, IGMP, ICMP, ARP, TCP, UDP, DHCP, PPPoE, RTP, RTSP, RTCP, DNS, DDNS, NTP, FTP, UPnP, HTTP, HTTPS, SMTP, 802.1x, SNMP, QoS, RTMP, SSL/TLS									
<b>Interface</b>										
Communication Interface:	10M/100M Base-TX Ethernet									
Local Storage:	Micro SD card up to 256 GB									
Audio Compression	G.711U, G.711A									
Audio I/O	1/1									
Alarm I/O	2/1									
<b>General</b>										
Safety	CE, IEC62368-1									
EMC	FCC Part 15, EN 55032:2015+A11:2020, EN 55035: 2017+A11:2020									
Operating Conditions:	Temperature: -40°C ~ 70°C (-40°F ~ 158°F), Humidity: ≤95% RH (Non-Condensing)									
Power Consumption:	Max 21.0 W									
Power Supply:	DC 12V±25% 3A, PoE+ (IEEE 802.3af)									
Weather Proof Rating:	IP67									
Vandal Resistant:	IK10									
Dimensions:	Ø166 x 295mm (Ø6.5" x 11.6")									
Net Weight:	3.05kg (6.72lb)									
Software:	No license required for use with Video Insight Software									
<b>Accessories</b>	<table border="0"> <tr> <td>M-PTZ Pendant </td> <td>M-PTZ-JB </td> <td>M-PTZ-WM </td> </tr> <tr> <td>M-PTZ Pendant-EX-S </td> <td>M-PTZ-CNR </td> <td>M-CM </td> </tr> <tr> <td>M-PTZ-PM </td> <td>M-Parapet </td> <td></td> </tr> </table>	M-PTZ Pendant 	M-PTZ-JB 	M-PTZ-WM 	M-PTZ Pendant-EX-S 	M-PTZ-CNR 	M-CM 	M-PTZ-PM 	M-Parapet 	
M-PTZ Pendant 	M-PTZ-JB 	M-PTZ-WM 								
M-PTZ Pendant-EX-S 	M-PTZ-CNR 	M-CM 								
M-PTZ-PM 	M-Parapet 